

Walk In Tub

OH 5126 Easy Access Out Swing Door



GENERAL SPECIFICATIONS

Dimensions51¼"×26"×39½"
 Weight198 lbs.
 Unoccupied capacity56-60 gallons

Features:

PVC Drain

- Size - 2"
- Horizontal or Vertical
- Plunger with Chain

Door

- Opening Width - 32"
- Door Opening Clearance Height - 20-1/2"
- Patented Door System Technology
- Aluminum Door and Frame

Acrylic Shell

- White or Biscuit Textured Acrylic
- White Smooth Acrylic
- Non-skid Floor
- ADA Height Seat
- Acrylic Surface with Fiberglass Substrate
- Two Grab Bars
- Stainless Steel Frame
- Front and Corner Deck for Faucet Locations

Options

- Left or Right Hand Drain
- Dual Air and Water Jetting System
- Water Jetting System
- Air Jetting System
- Loaded Jetted Package

Accessories

- Tub Extension Panel Kit
- Back Wall Extension Panel Kit
- End Panel Kit
- Shower Wall Kit

Compliance Certifications - Meets or Exceeds the Following Specifications:

- cETL - Intertek
- cUPC / USPC - IAPMO
- ANSI Z 124.1.2 - for Plastic Bathtubs
- ASME A 112.19.7 - Whirlpool Appliances
- ASME A 122.19.15 - for Walk In Bathtubs
- CSA B45.4 - Canadian Plumbing Fixtures



Right Hand Shown

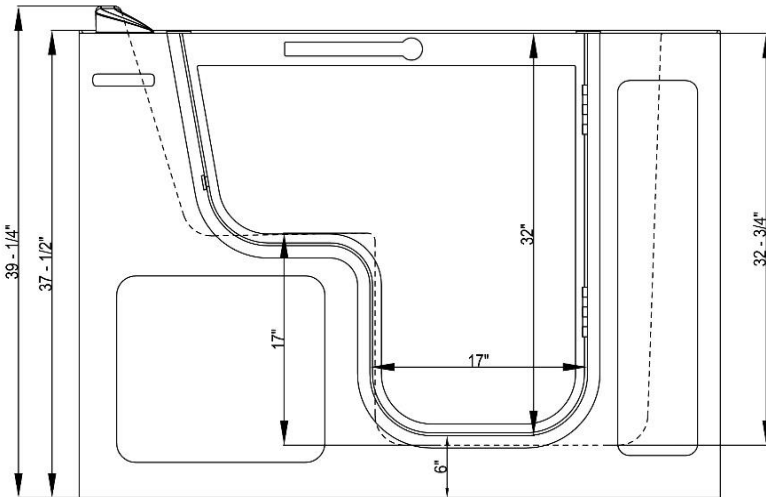

Front View

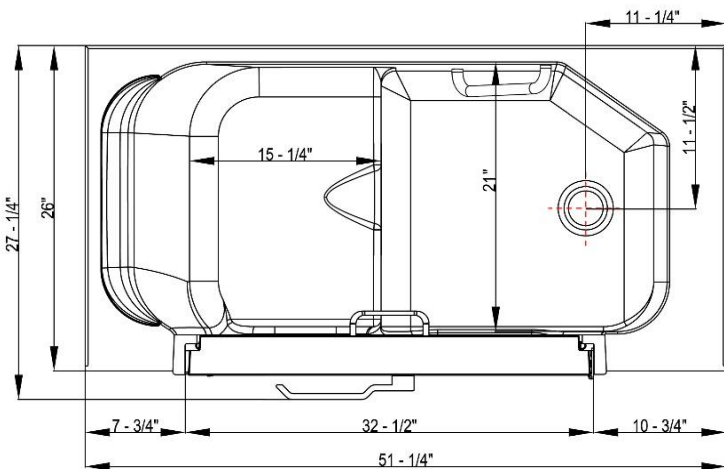

Top View

In an effort to continually improve our product, specifications and configurations are subject to change without notice.

Before ordering or installing, consider future access to essential equipment.